

BU406, BU407 NPN SILICON POWER TRANSISTORS

Copyright © 1997, Power Innovations Limited, UK

AUGUST 1978 - REVISED MARCH 1997

- 7 A Continuous Collector Current
- 15 A Peak Collector Current
- 60 W at 25°C Case Temperature

TO-220 PACKAGE
(TOP VIEW)

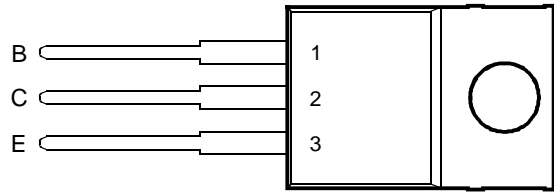

Pin 2 is in electrical contact with the mounting base.

MDTRACA

absolute maximum ratings at 25°C case temperature (unless otherwise noted)

RATING		SYMBOL	VALUE	UNIT
Collector-base voltage ($I_E = 0$)	BU406	V_{CBO}	400	V
	BU407		330	
Collector-emitter voltage ($V_{BE} = -2$ V)	BU406	V_{CEX}	400	V
	BU407		330	
Collector-emitter voltage ($I_B = 0$)	BU406	V_{CEO}	200	V
	BU407		150	
Emitter-base voltage		V_{EB}	6	V
Continuous collector current		I_C	7	A
Peak collector current (see Note 1)		I_{CM}	15	A
Continuous base current		I_B	4	A
Continuous device dissipation at (or below) 25°C case temperature		P_{tot}	60	W
Operating junction temperature range		T_j	-55 to +150	°C
Storage temperature range		T_{stg}	-55 to +150	°C

NOTE 1: This value applies for $t_p \leq 10$ ms, duty cycle $\leq 2\%$.

PRODUCT INFORMATION

Information is current as of publication date. Products conform to specifications in accordance with the terms of Power Innovations standard warranty. Production processing does not necessarily include testing of all parameters.

BU406, BU407

NPN SILICON POWER TRANSISTORS

AUGUST 1978 - REVISED MARCH 1997

electrical characteristics at 25°C case temperature (unless otherwise noted)

PARAMETER	TEST CONDITIONS			MIN	TYP	MAX	UNIT
$V_{(BR)CEO}$ Collector-emitter breakdown voltage	$I_C = 30 \text{ mA}$	$I_B = 0$		140			V
I_{CES} Collector-emitter cut-off current	$V_{CE} = 400 \text{ V}$	$V_{BE} = 0$	BU406			5	mA
	$V_{CE} = 330 \text{ V}$	$V_{BE} = 0$	BU407			5	
	$V_{CE} = 250 \text{ V}$	$V_{BE} = 0$	BU406			0.1	
	$V_{CE} = 200 \text{ V}$	$V_{BE} = 0$	BU407			0.1	
	$V_{CE} = 250 \text{ V}$	$V_{BE} = 0$	$T_C = 150^\circ\text{C}$	BU406		1	
	$V_{CE} = 200 \text{ V}$	$V_{BE} = 0$	$T_C = 150^\circ\text{C}$	BU407		1	
I_{EBO} Emitter cut-off current	$V_{EB} = 6 \text{ V}$	$I_C = 0$				1	mA
h_{FE} Forward current transfer ratio	$V_{CE} = 10 \text{ V}$	$I_C = 4 \text{ A}$	(see Notes 2 and 3)	12			
	$V_{CE} = 10 \text{ V}$	$I_C = 0.5 \text{ A}$		20			
$V_{CE(sat)}$ Collector-emitter saturation voltage	$I_B = 0.5 \text{ A}$	$I_C = 5 \text{ A}$	(see Notes 2 and 3)			1	V
$V_{BE(sat)}$ Base-emitter saturation voltage	$I_B = 0.5 \text{ A}$	$I_C = 5 \text{ A}$	(see Notes 2 and 3)			1.2	V
f_t Current gain bandwidth product	$V_{CE} = 5 \text{ V}$	$I_C = 0.5 \text{ A}$	$f = 1 \text{ MHz}$ (see Note 4)		6		MHz
C_{ob} Output capacitance	$V_{CB} = 20 \text{ V}$	$I_E = 0$	$f = 1 \text{ MHz}$		60		pF

NOTES: 2. These parameters must be measured using pulse techniques, $t_p = 300 \mu\text{s}$, duty cycle $\leq 2\%$.

3. These parameters must be measured using voltage-sensing contacts, separate from the current carrying contacts.

4. To obtain f_t the $[h_{FE}]$ response is extrapolated at the rate of -6 dB per octave from $f = 1 \text{ MHz}$ to the frequency at which $[h_{FE}] = 1$.

thermal characteristics

PARAMETER	MIN	TYP	MAX	UNIT
$R_{\theta JC}$ Junction to case thermal resistance			2.08	$^\circ\text{C}/\text{W}$
$R_{\theta JA}$ Junction to free air thermal resistance			70	$^\circ\text{C}/\text{W}$

inductive-load-switching characteristics at 25°C case temperature (unless otherwise noted)

PARAMETER	TEST CONDITIONS †			MIN	TYP	MAX	UNIT
t_s Storage time	$I_C = 5 \text{ A}$	$I_{B(end)} = 0.5 \text{ A}$	(see Figures 1 and 2)		2.7		μs
$t_{(off)}$ Turn off time						750	ns

† Voltage and current values shown are nominal; exact values vary slightly with transistor parameters.

PARAMETER MEASUREMENT INFORMATION

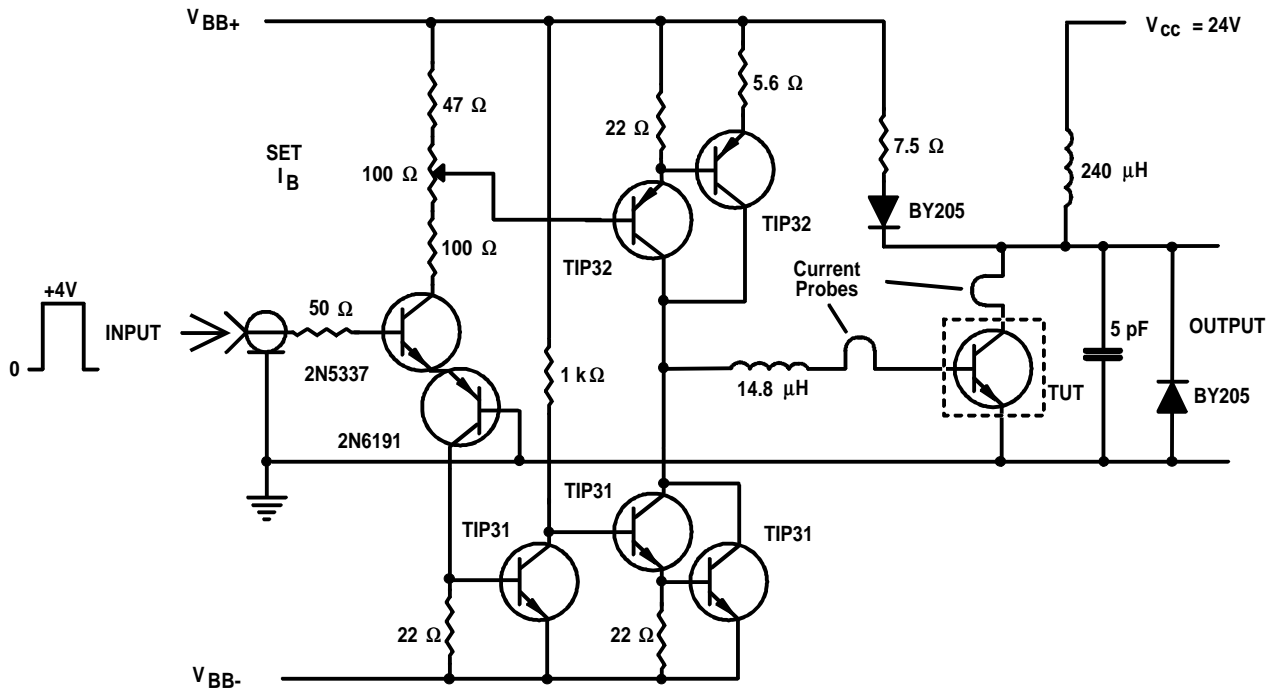
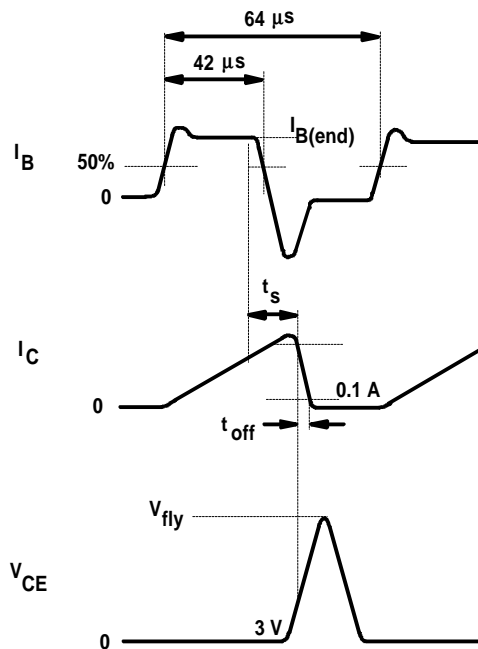

Figure 1. Inductive-Load Switching Test Circuit



t_{off} is the time for the collector current I_C to decrease to 0.1 A after the collector to emitter voltage V_{CE} has risen 3 V into its flyback excursion.

Figure 2. Inductive-Load Switching Waveforms

BU406, BU407 NPN SILICON POWER TRANSISTORS

AUGUST 1978 - REVISED MARCH 1997

TYPICAL CHARACTERISTICS

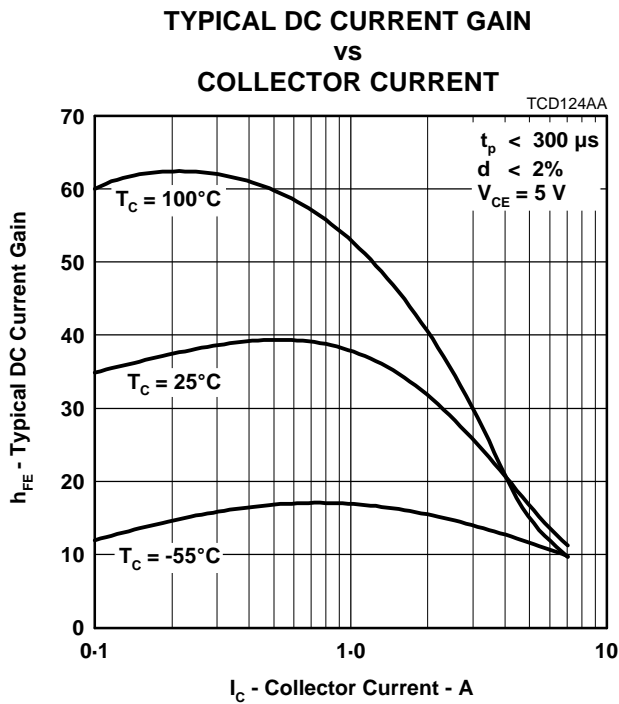

Figure 3.

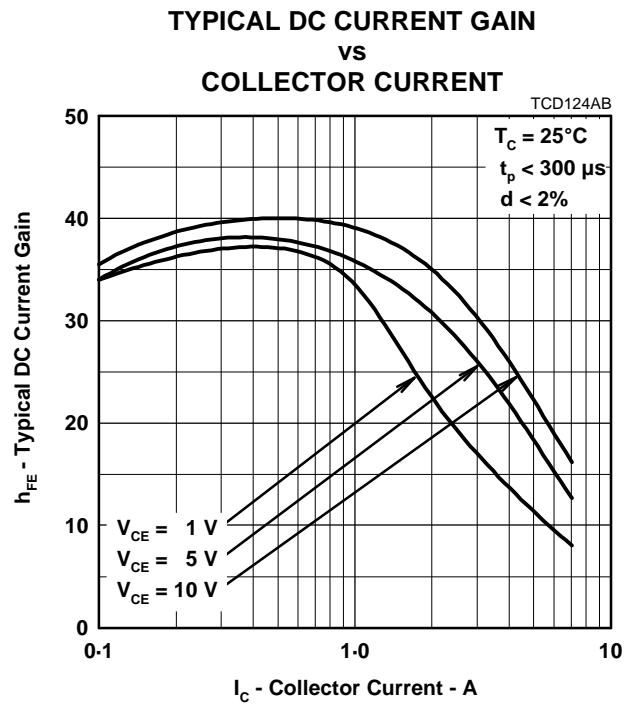

Figure 4.

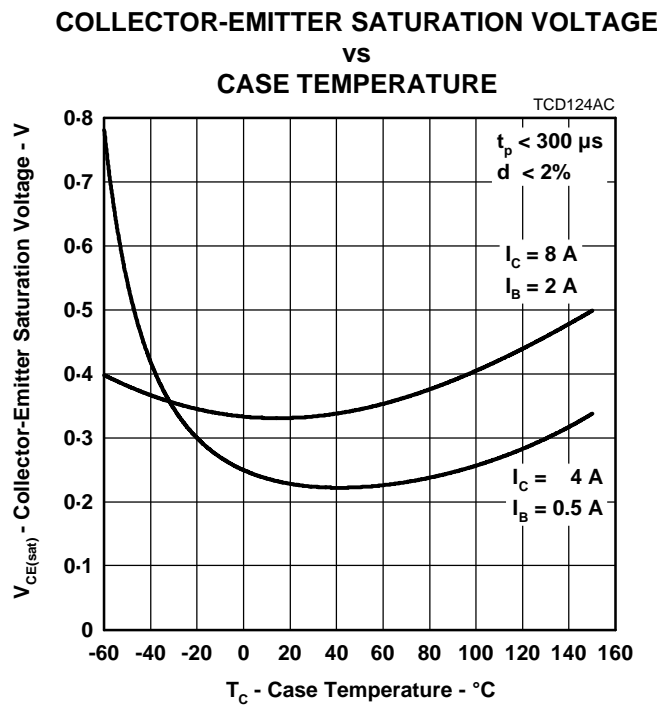

Figure 5.

MAXIMUM SAFE OPERATING REGIONS

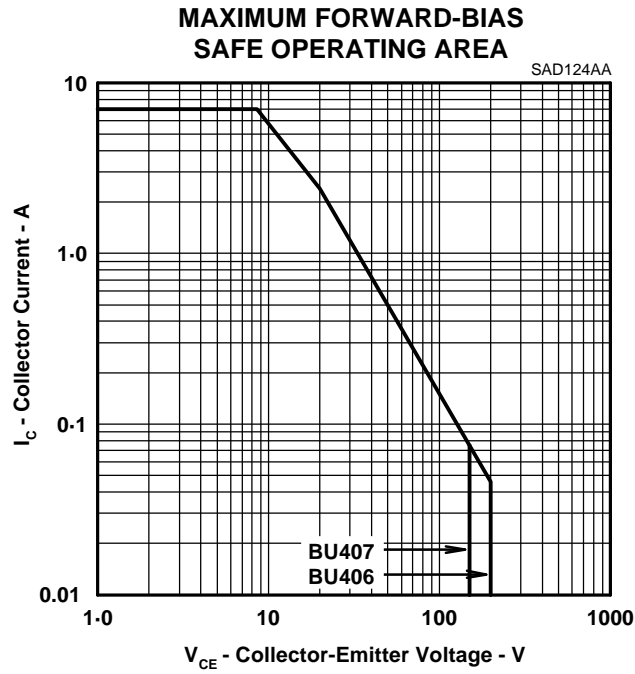

Figure 6.

BU406, BU407 NPN SILICON POWER TRANSISTORS

AUGUST 1978 - REVISED MARCH 1997

MECHANICAL DATA

TO-220

3-pin plastic flange-mount package

This single-in-line package consists of a circuit mounted on a lead frame and encapsulated within a plastic compound. The compound will withstand soldering temperature with no deformation, and circuit performance characteristics will remain stable when operated in high humidity conditions. Leads require no additional cleaning or processing when used in soldered assembly.

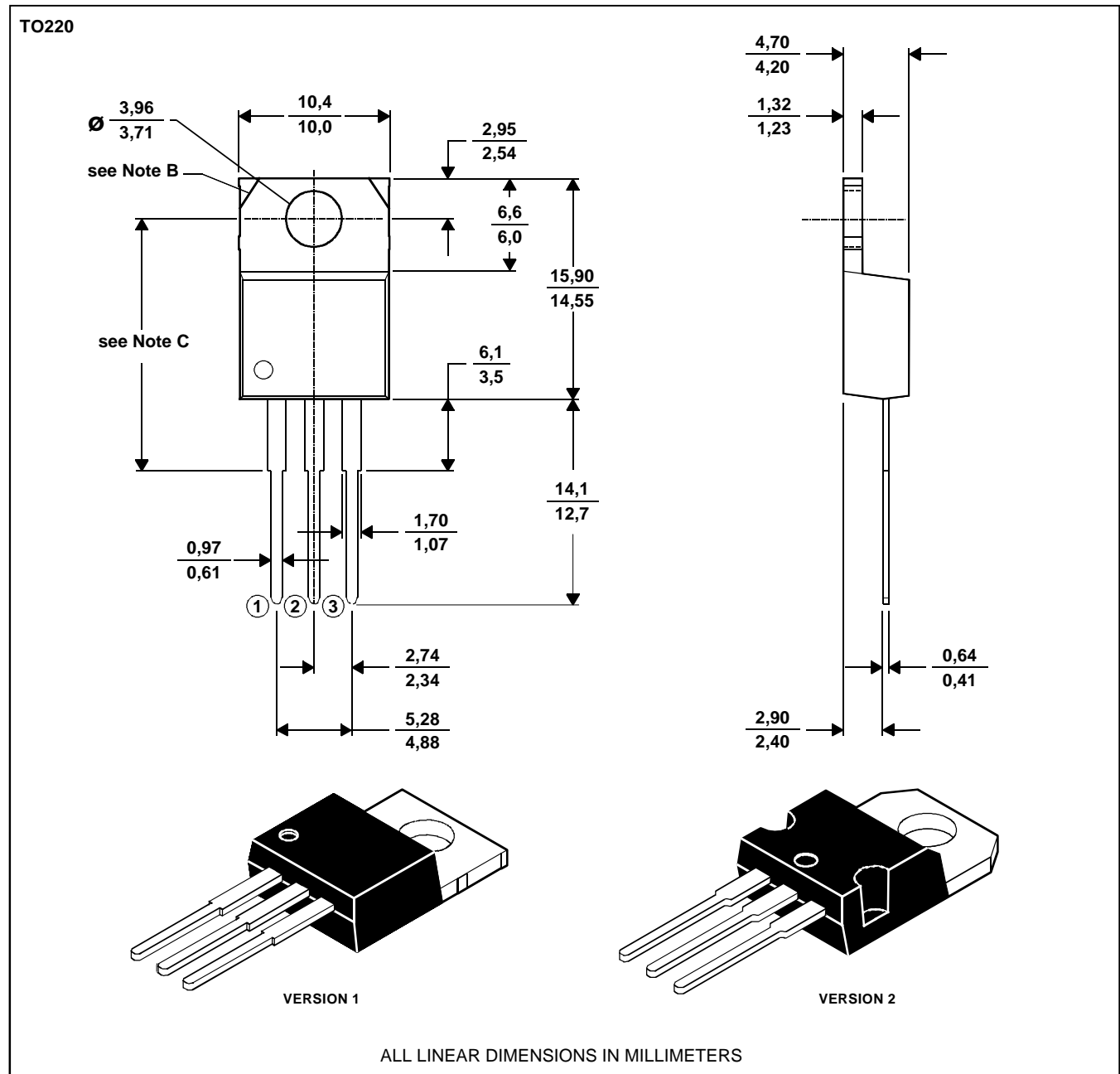

- NOTES: A. The centre pin is in electrical contact with the mounting tab.
 B. Mounting tab corner profile according to package version.
 C. Typical fixing hole centre stand off height according to package version.
 Version 1, 18.0 mm. Version 2, 17.6 mm.

MDXXBE

PRODUCT INFORMATION

IMPORTANT NOTICE

Power Innovations Limited (PI) reserves the right to make changes to its products or to discontinue any semiconductor product or service without notice, and advises its customers to verify, before placing orders, that the information being relied on is current.

PI warrants performance of its semiconductor products to the specifications applicable at the time of sale in accordance with PI's standard warranty. Testing and other quality control techniques are utilized to the extent PI deems necessary to support this warranty. Specific testing of all parameters of each device is not necessarily performed, except as mandated by government requirements.

PI accepts no liability for applications assistance, customer product design, software performance, or infringement of patents or services described herein. Nor is any license, either express or implied, granted under any patent right, copyright, design right, or other intellectual property right of PI covering or relating to any combination, machine, or process in which such semiconductor products or services might be or are used.

PI SEMICONDUCTOR PRODUCTS ARE NOT DESIGNED, INTENDED, AUTHORIZED, OR WARRANTED TO BE SUITABLE FOR USE IN LIFE-SUPPORT APPLICATIONS, DEVICES OR SYSTEMS.

Copyright © 1997, Power Innovations Limited